

4

0 - 1 - 2 - 3 - 4 - 5 - 6 - 7 - 8 - 9 - 10

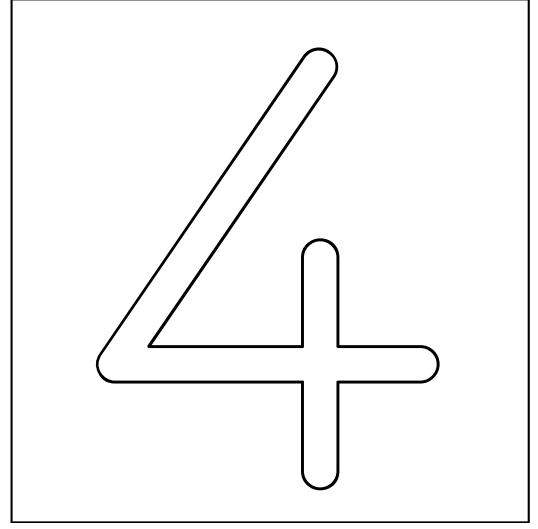

"4" Rakamındaki noktaları birleştirelim ve yazalım.

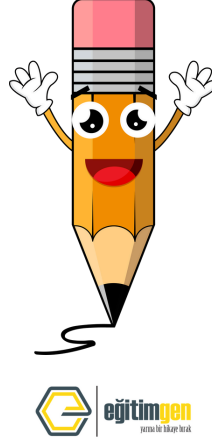
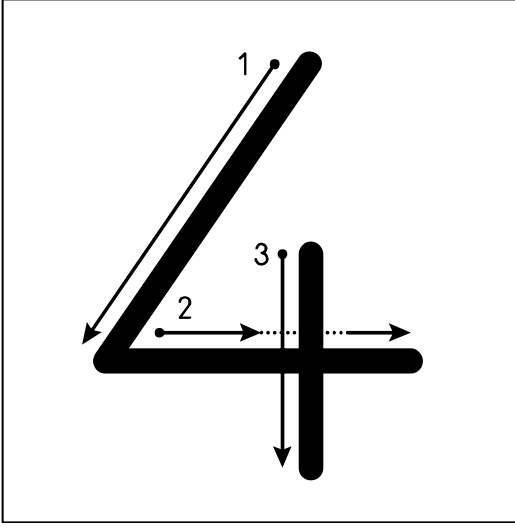
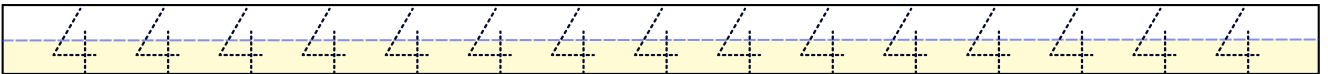
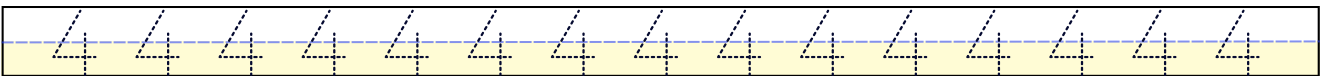
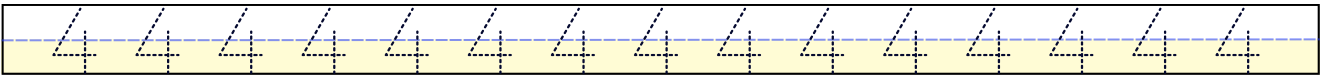
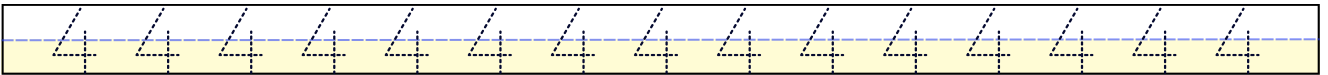
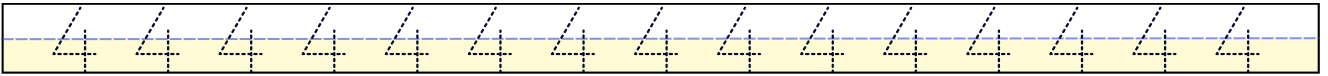
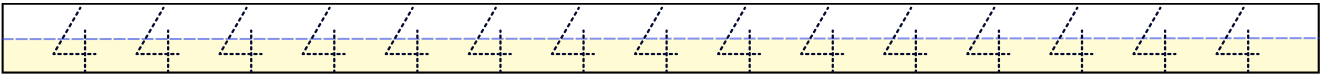
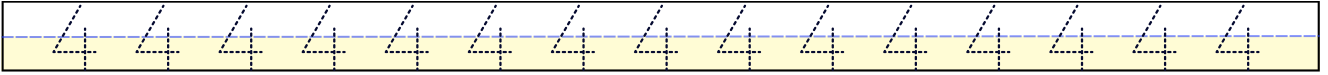
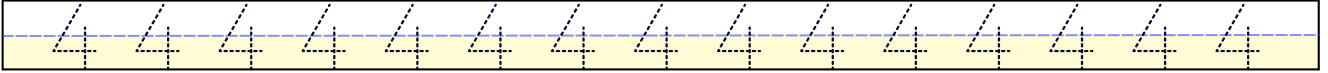

4

0 - 1 - 2 - 3 - 4 - 5 - 6 - 7 - 8 - 9 - 10

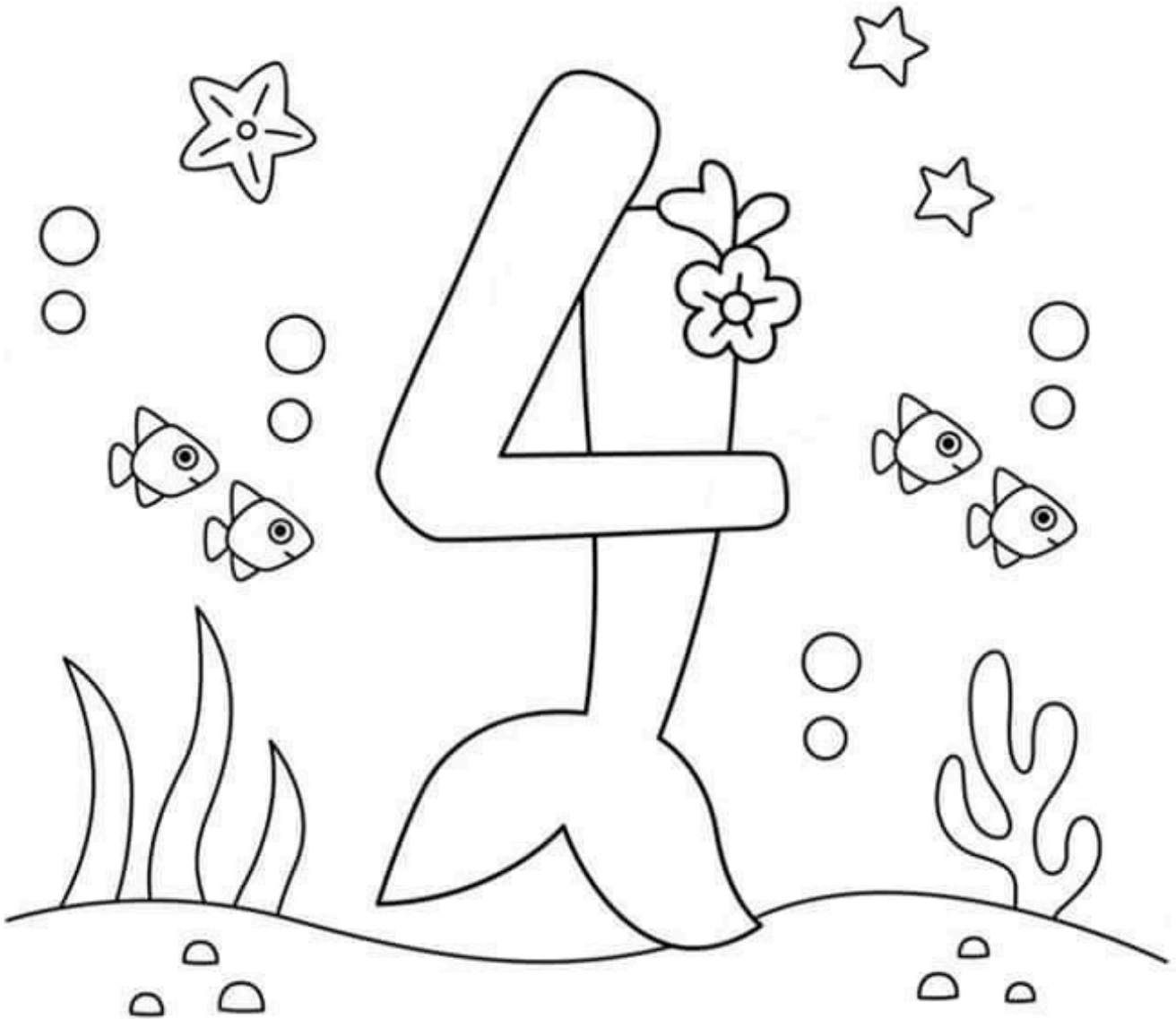

4 4 4 4 4 4 4 4 4 4 4 4 4 4 4

4 4 4 4 4 4

4 4 4 4

4 4 4

4 4