

Aşağıda görselleri verilen varlıkların adlarını söyleyelim. Adlarında "B" sesi olan varlıkların altındaki kutucuğu işaretleyelim.



















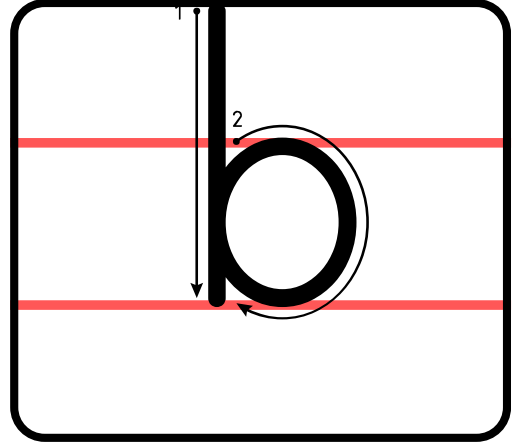
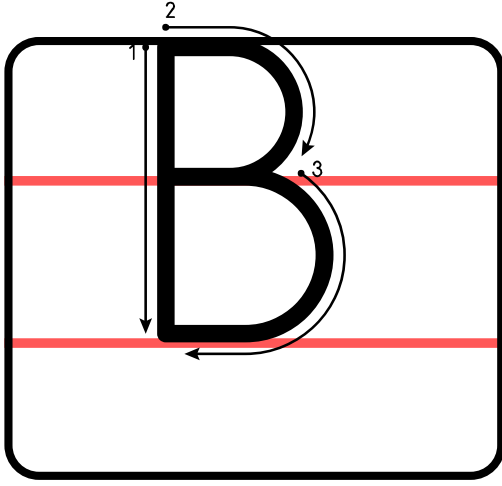

Aşağıda görselleri verilen varlıkların adlarını söyleyelim. Adlarındaki "B-b" sesi başta mı, ortada mı, sonda mı işaretleyelim.





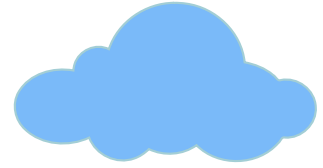













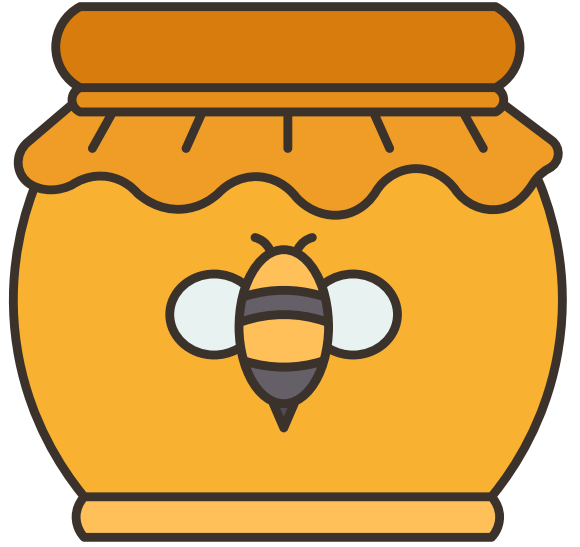
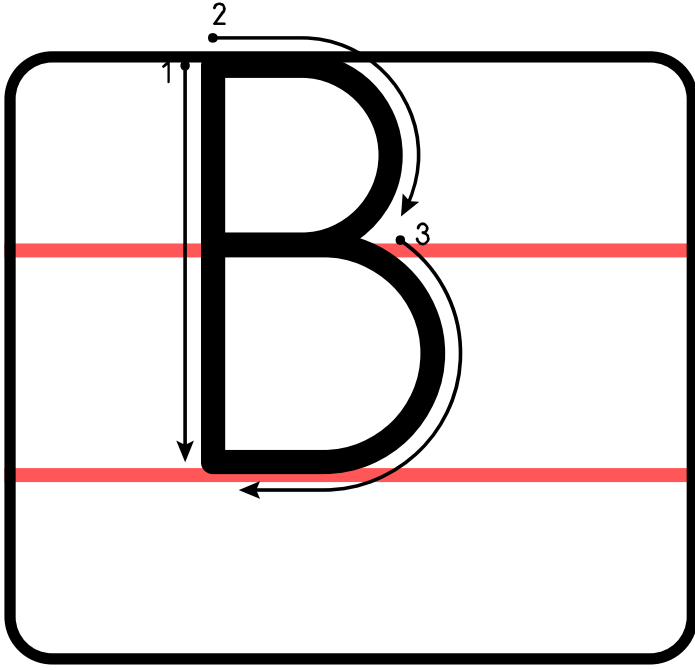

Bal

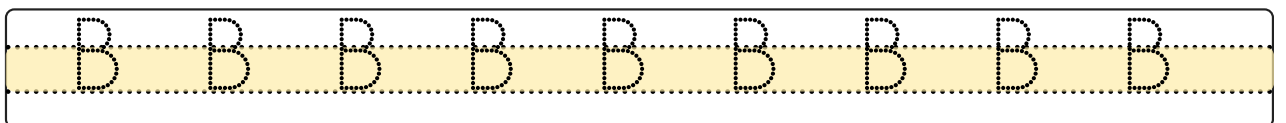
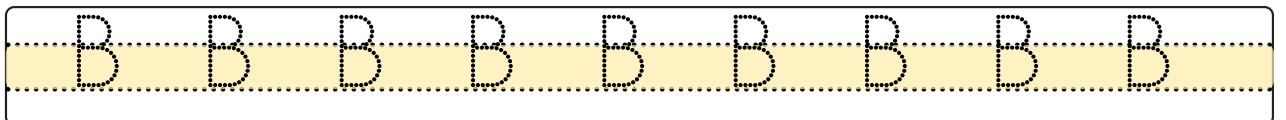
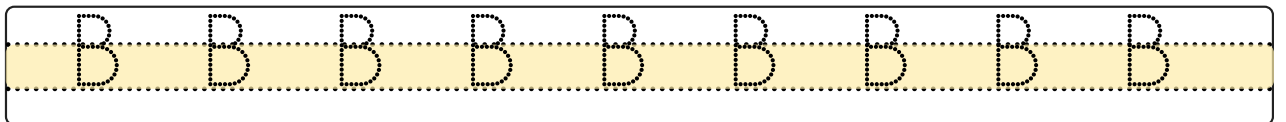
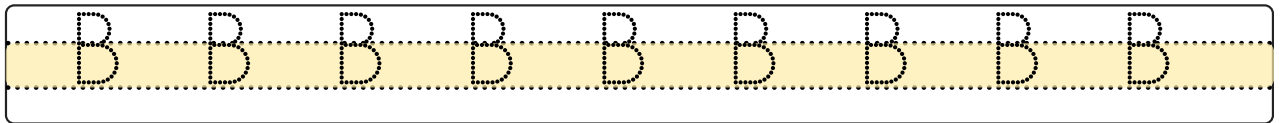
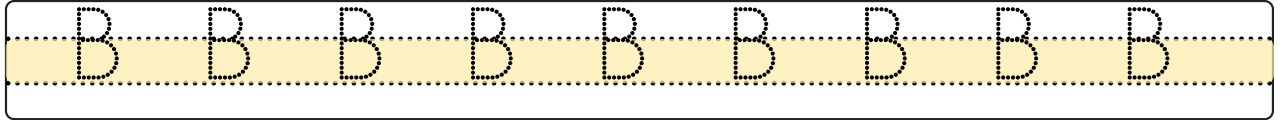
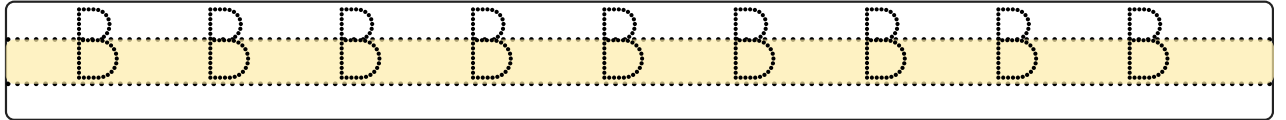

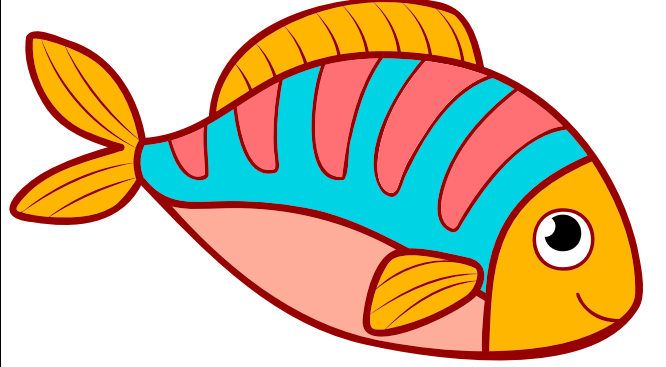
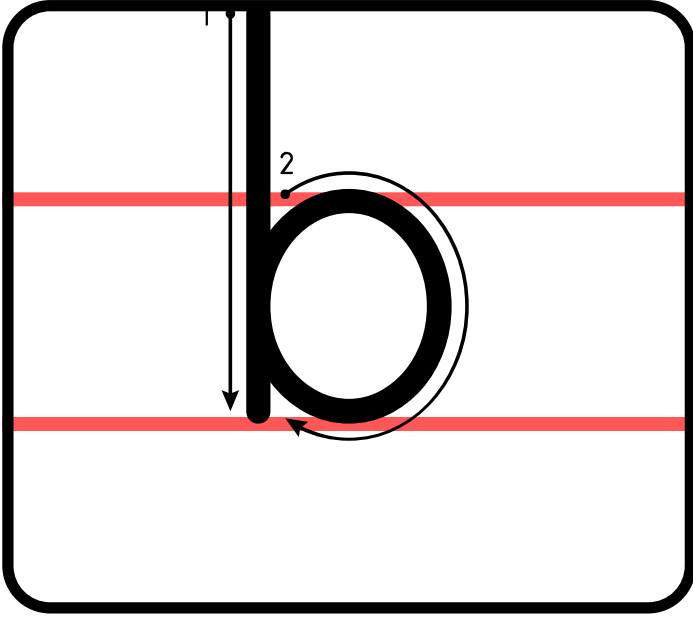

balık

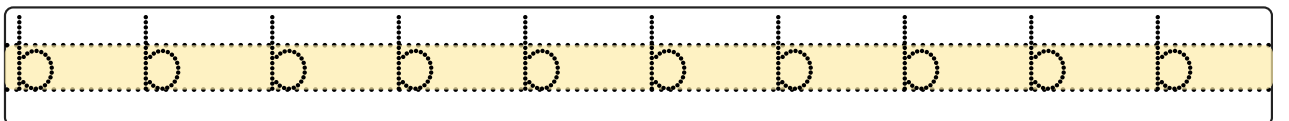
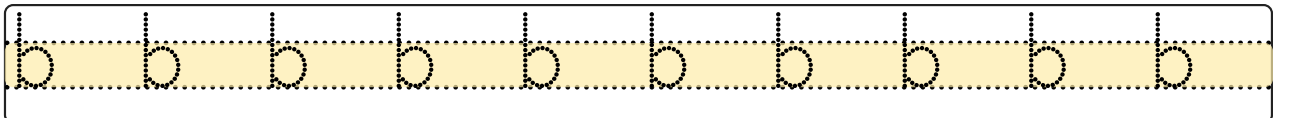
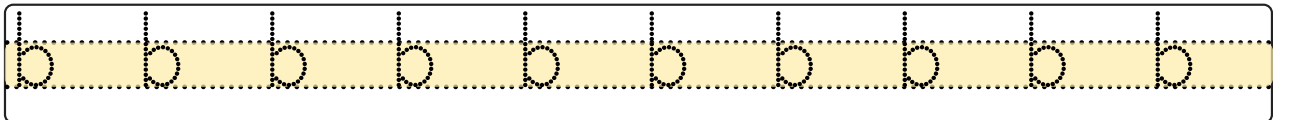
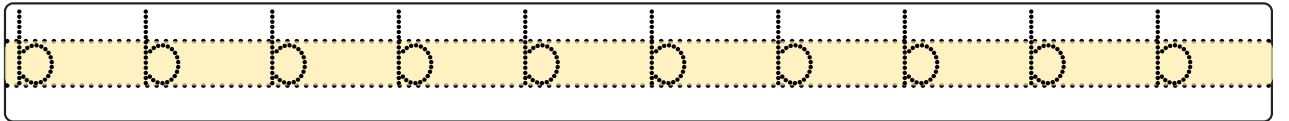
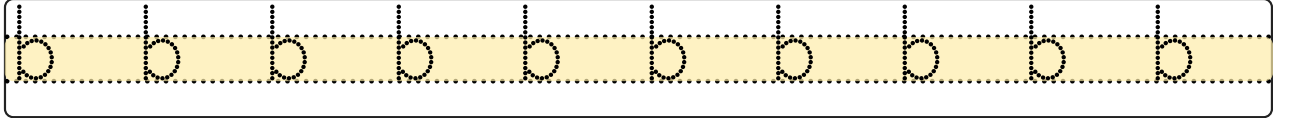
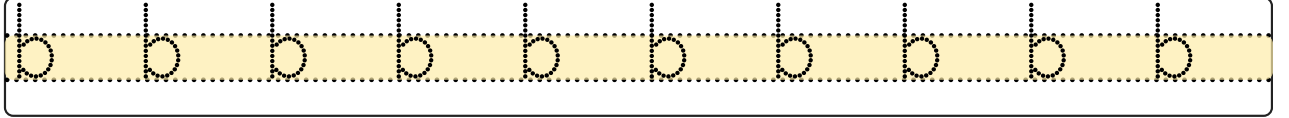

ADI SOYADI:

ETKİNLİK ADI: HARF OKUMA-YAZMA ÇALIŞMASI



B b B b B b B b B b

B b

B b

B b

B b

B b

B b

B b

B b

B b

B b

ADI SOYADI:

ETKİNLİK ADI: HARF OKUMA-YAZMA ÇALIŞMASI

e

b

eb

eb

eb

eb

b

e

be

be

be

be

ADI SOYADI:

ETKİNLİK ADI: HARF OKUMA-YAZMA ÇALIŞMASI

a

b

ab

ab

ab

ab

b

o

bo

bo

bo

bo

Aşağıdaki heceleri okuyup birer satır yazalım.

eb

ab

ob

ub

üb

öb

ib

ba

be

bi

bı

Aşağıdaki heceleri okuyup birer satır yazalım.

bel

bal

bak

ben

bin

bom

bar

bat

bot

bul

bil

Aşağıdaki kelimeleri okuyup birer satır yazalım.

bana

bala

bere

Bora

biri

boru

bulma

bakma

bilme

bölme

burnu

Aşağıdaki kelimeleri okuyup birer satır yazalım.

balık

basit

baba

Berna

bakla

botlu

butlu

binme

buldu

burun

borulu

Aşağıdaki kelimeleri okuyup birer satır yazalım.

Ebru

Sabri

Bekir

Bora

Berke

Abla

Bakır

Batak

Tabak

Banyo

Borç

Aşağıdaki cümleleri okuyalım, yazalım.

Bu akşam bere taktım.

Ekmek ile bal yedim.

Bir bardak süt içtim.

Berna beyaz balina gördü.

Beyaz elbisemi giydim.

Bir bardak mısır aldım.