

ADI SOYADI:

1.SINIF

1.SINIF İLK OKUMA YAZMA HARFLER

HARF FASİKÜLÜ

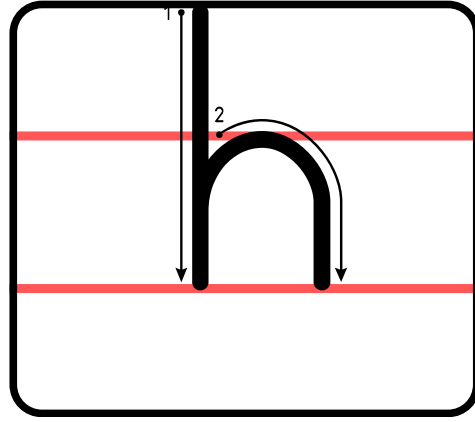
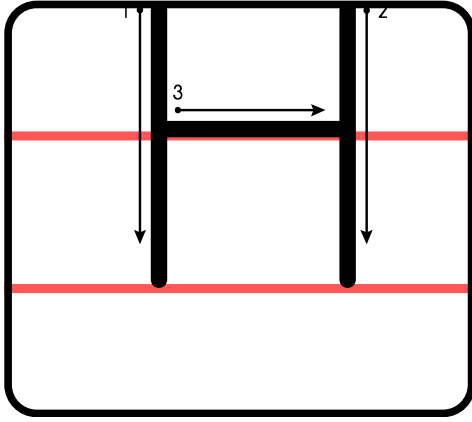

Aşağıda görselleri verilen varlıkların adlarını söyleyelim. Adlarında "h" sesi olan varlıkların altındaki kutucuğu işaretleyelim.

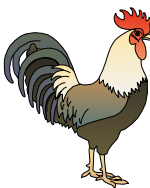
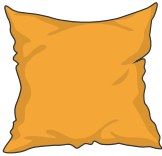

ADI SOYADI:

1.SINIF

1.SINIF İLK OKUMA YAZMA HARFLER

HARF FASİKÜLÜ

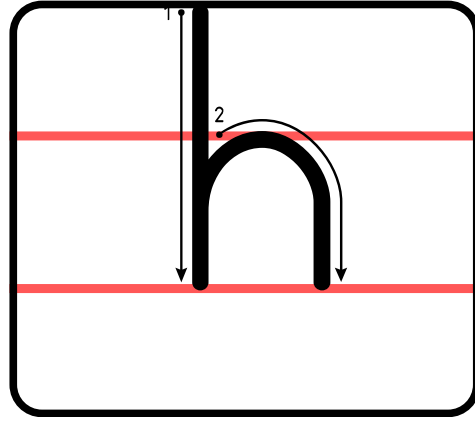
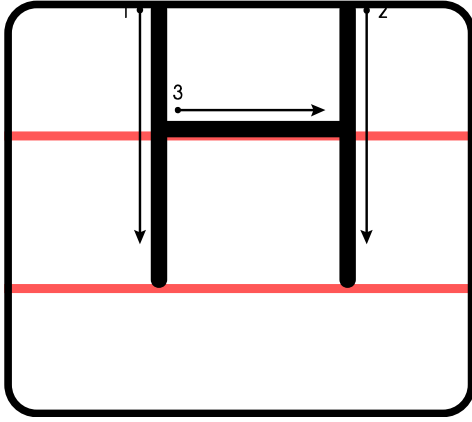

Aşağıda görselleri verilen varlıkların adlarını söyleyelim. Adlarındaki "h" sesi başta mı, ortada mı, sonda mı işaretleyelim.

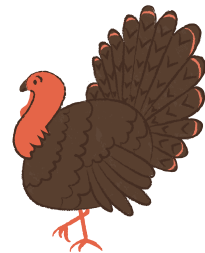

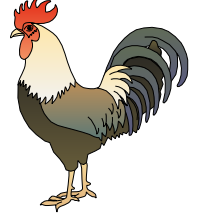
"H ve h" harflerinin üzerinden geçerek yazalım.



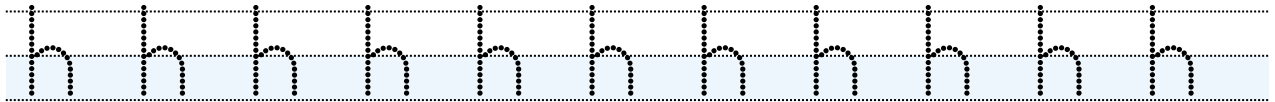
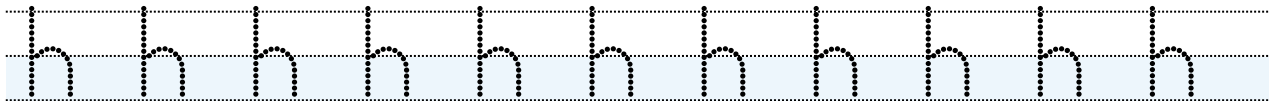
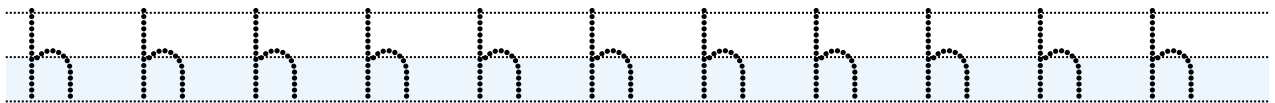
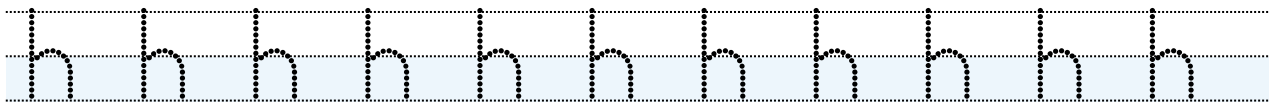

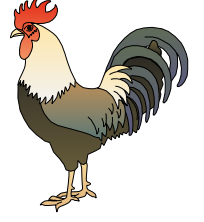
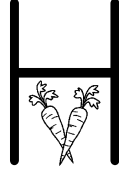
"H ve h" harflerinin üzerinden geçerek yazalım.

H H H H

H H H

H H

H

h h h h

h h h

h h

h

ADI SOYADI:

1.SINIF

1.SINIF İLK OKUMA YAZMA HARFLER

HARF FASİKÜLÜ

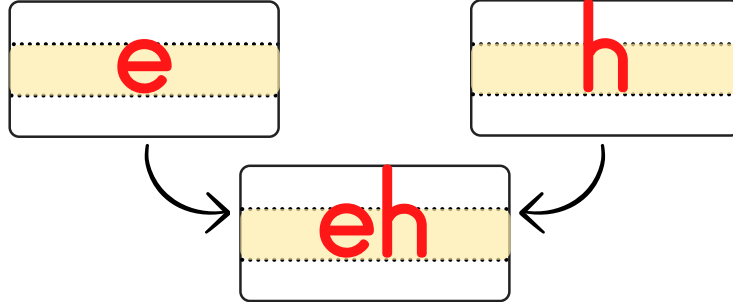

eh

eh

eh

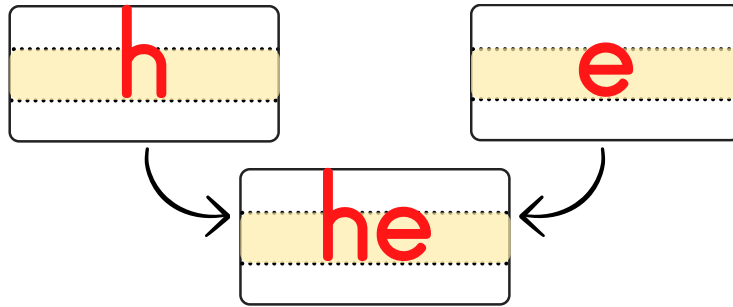

he

he

he

ADI SOYADI:

1.SINIF

1.SINIF İLK OKUMA YAZMA HARFLER

HARF FASİKÜLÜ

ha

lı

halı

halı

halı

halı

he

ce

hece

hece

hece

hece

ADI SOYADI:

1.SINIF

1.SINIF İLK OKUMA YAZMA HARFLER

HARF FASİKÜLÜ

sa

ha

saha

saha

saha

saha

hu

ni

huni

huni

huni

huni

ADI SOYADI:

1.SINIF

1.SINIF İLK OKUMA YAZMA HARFLER

HARF FASİKÜLÜ

ham le  
hamle

hamle

hamle

hamle

has ta  
hasta

hasta

hasta

hasta



ADI SOYADI:

1.SINIF

1.SINIF İLK OKUMA YAZMA HARFLER

HARF FASİKÜLÜ

Aşağıdaki heceleri okuyup birer satır yazalım.

eh

ah

oh

öh

ih

ih

uh

üh

ha

he

ADI SOYADI:

1.SINIF

1.SINIF İLK OKUMA YAZMA HARFLER

HARF FASİKÜLÜ

Aşağıdaki hece ve kelimeleri okuyup birer satır yazalım.

has

hat

hak

hes

hep

hel

hık

hol

hök

huk

ADI SOYADI:

1.SINIF

1.SINIF İLK OKUMA YAZMA HARFLER

HARF FASİKÜLÜ

Aşağıdaki sözcükleri okuyup birer satır yazalım.

halı

saha

huni

ahır

hece

hamur

sahte

seher

sabah

halil

ADI SOYADI:

1.SINIF

1.SINIF İLK OKUMA YAZMA HARFLER

HARF FASİKÜLÜ

Aşağıdaki sözcükleri okuyup birer satır yazalım.

bahçe

hasret

hasır

horoz

tohum

timsah

hilal

nehir

hamak

hızlı

ADI SOYADI:

1.SINIF

1.SINIF İLK OKUMA YAZMA HARFLER

HARF FASİKÜLÜ

Aşağıdaki sözcükleri okuyup birer satır yazalım.

anahtar

hastane

hatıra

lahana

bahane

şahane

haşlama

hüzünlü

hesaplı

hoplama

ADI SOYADI:

1.SINIF

1.SINIF İLK OKUMA YAZMA HARFLER

HARF FASİKÜLÜ

Aşağıdaki cümleleri okuyalım, yazalım.

Can çıkmayınca huy çıkmaz.

Handwriting practice line with a yellow background and a dashed line for the middle.

Bu fırsat her zaman gelmez.

Handwriting practice line with a yellow background and a dashed line for the middle.

Hayrettin hamama gitmiş.

Handwriting practice line with a yellow background and a dashed line for the middle.

Hüseyin çilli horoz besledi.

Handwriting practice line with a yellow background and a dashed line for the middle.

Halam ile annem halı yıkadı.

Handwriting practice line with a yellow background and a dashed line for the middle.

Hülya hecelemeden okuyor.

Handwriting practice line with a yellow background and a dashed line for the middle.

ADI SOYADI:

1.SINIF

1.SINIF İLK OKUMA YAZMA HARFLER

HARF FASİKÜLÜ

Aşağıdaki cümleleri okuyalım, yazalım.

Annem bana hikaye aldı.

Handwriting practice line with a yellow background and a dotted line for tracing.

Bu lahananın tadı harika.

Handwriting practice line with a yellow background and a dotted line for tracing.

Derste helikopter resmi yaptım.

Handwriting practice line with a yellow background and a dotted line for tracing.

Sabah sabah horoz ötüyor.

Handwriting practice line with a yellow background and a dotted line for tracing.

Bahçede timsah beslenir mi?

Handwriting practice line with a yellow background and a dotted line for tracing.

Halam bahçede hindi besliyor.

Handwriting practice line with a yellow background and a dotted line for tracing.